

1

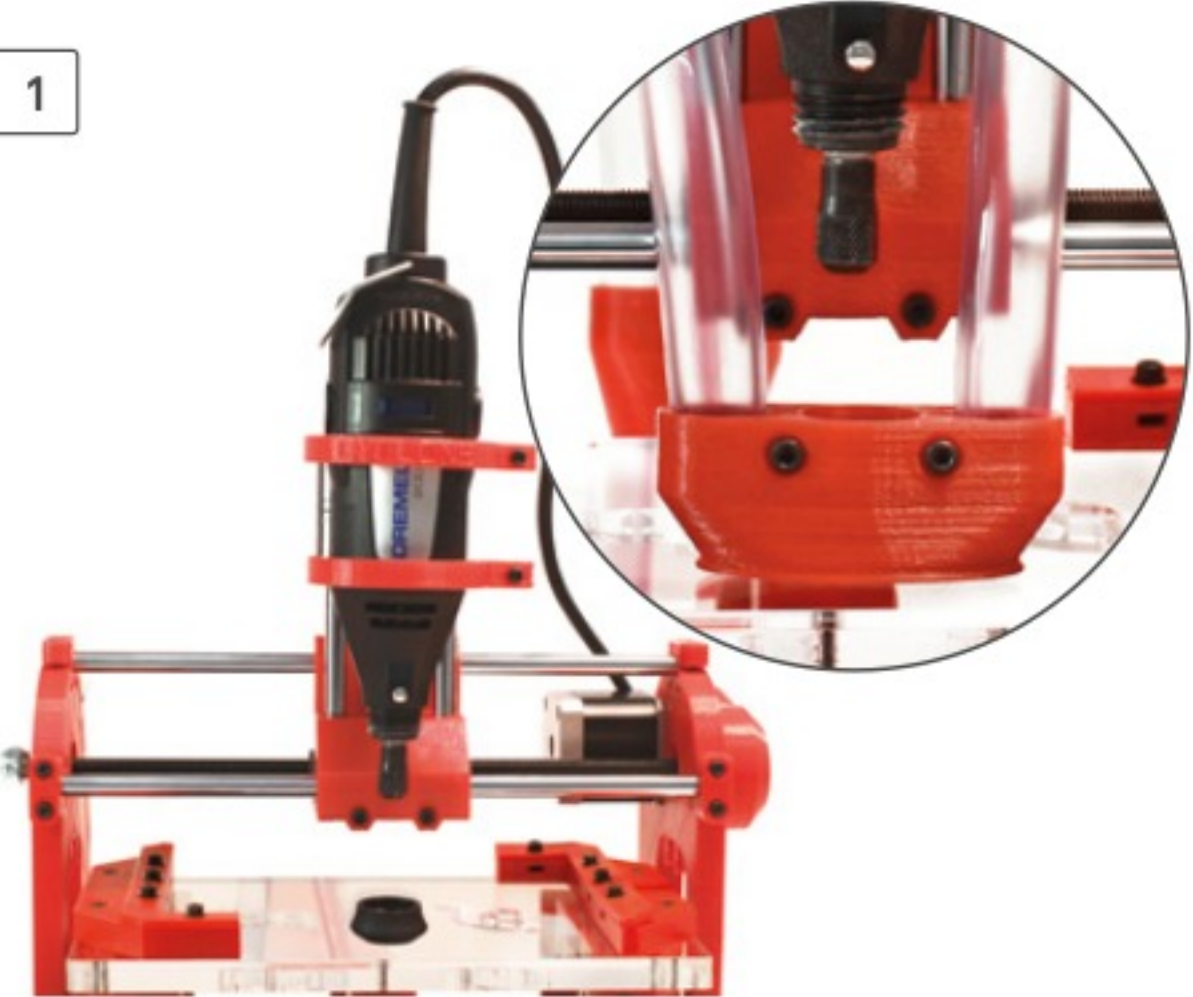

2



3



4

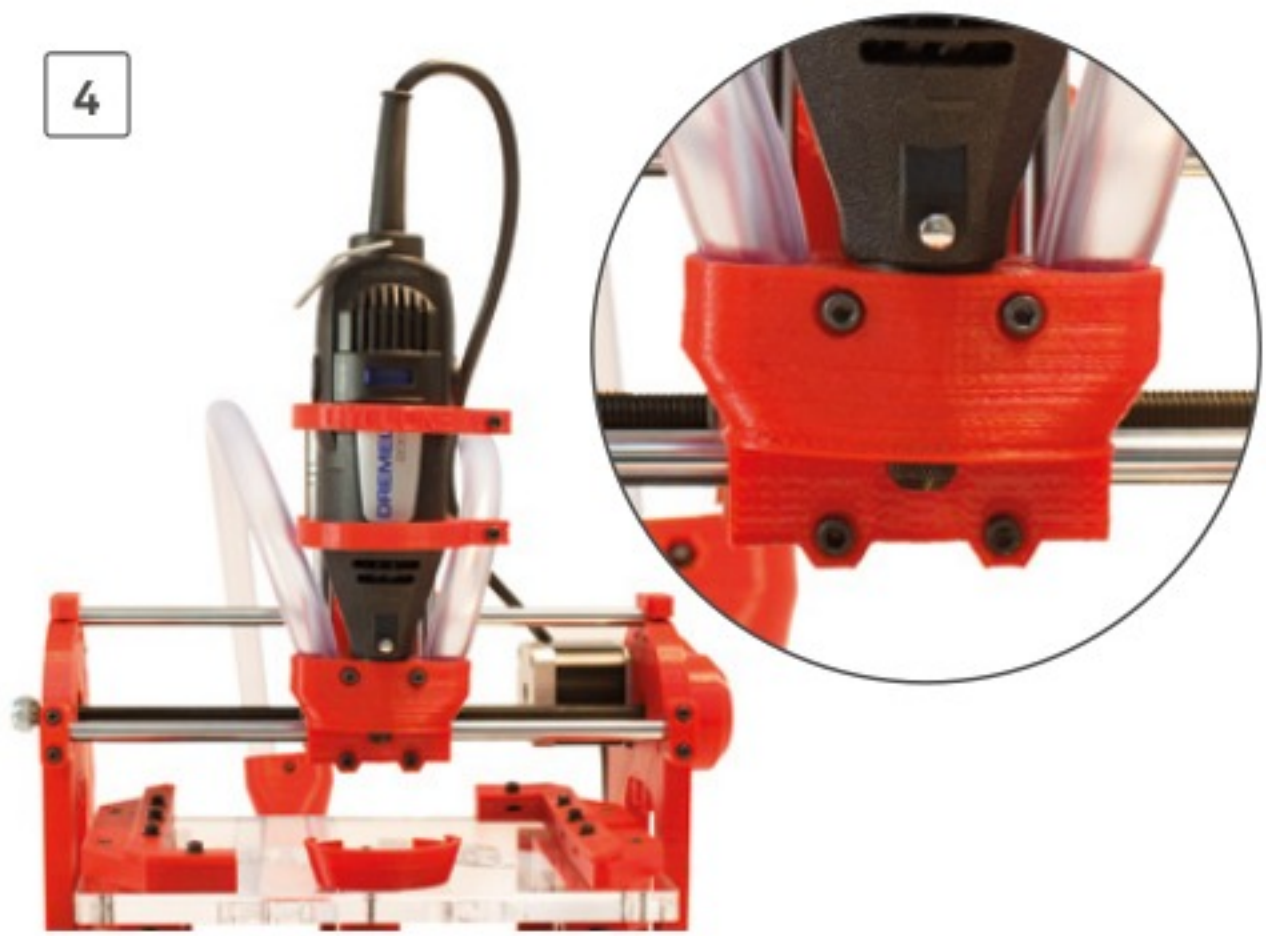

**A**



x1

**B**



x1

1



2



1



2



A



x1

B



x2

C



x2

1



2



3



4





**A****x1****B****x1****C****x1****D****x1**

1

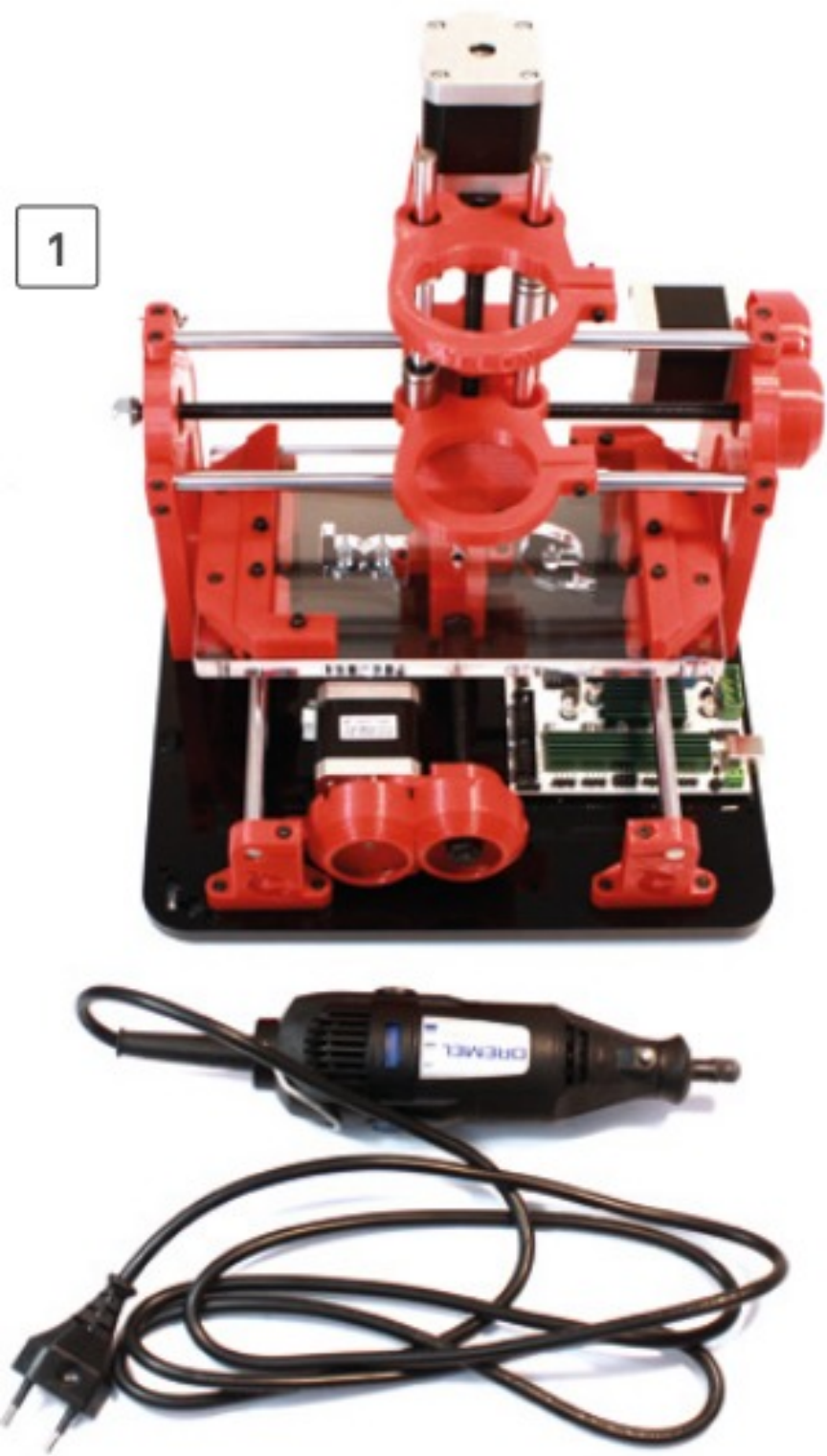

2

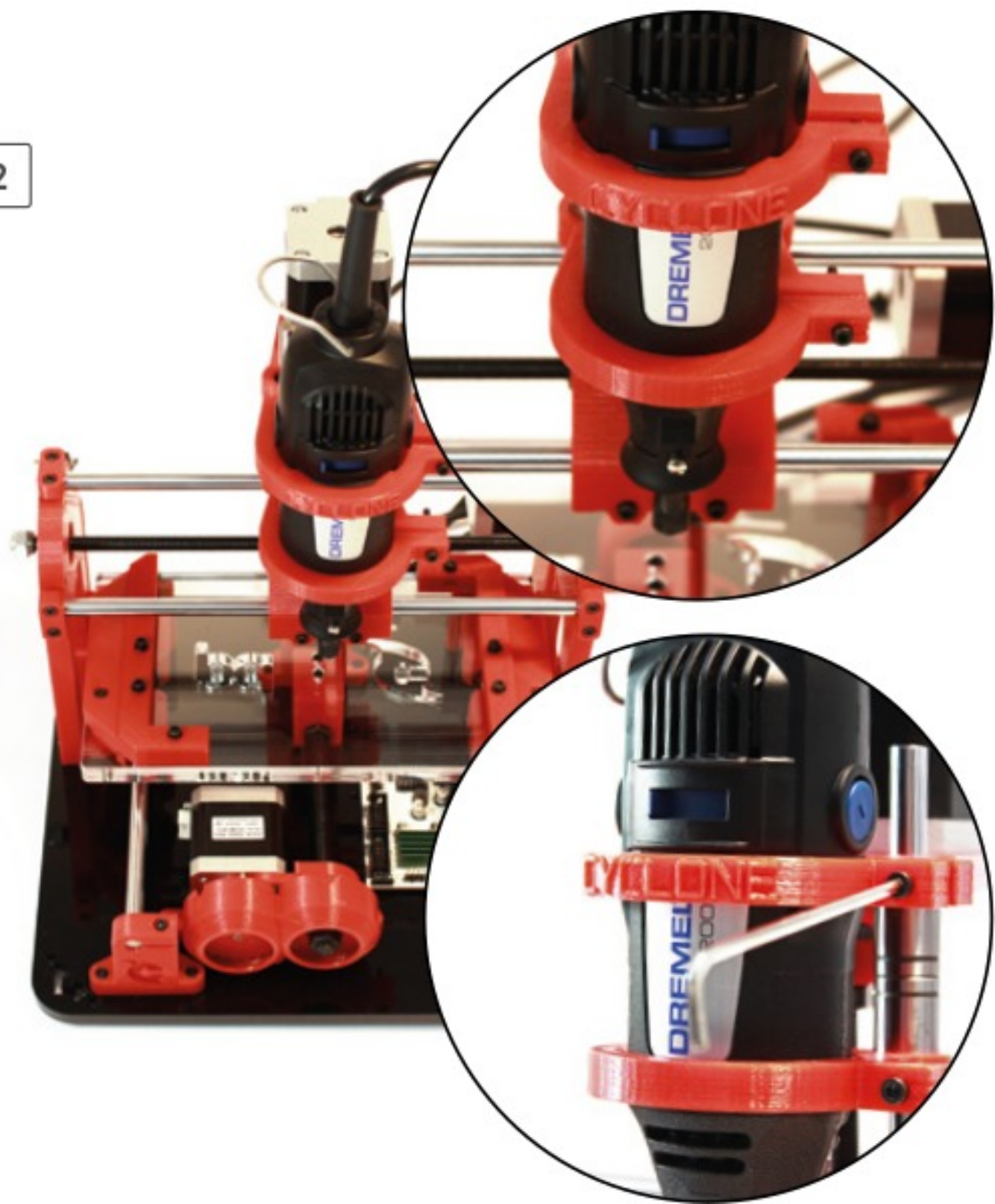

A



x1



1

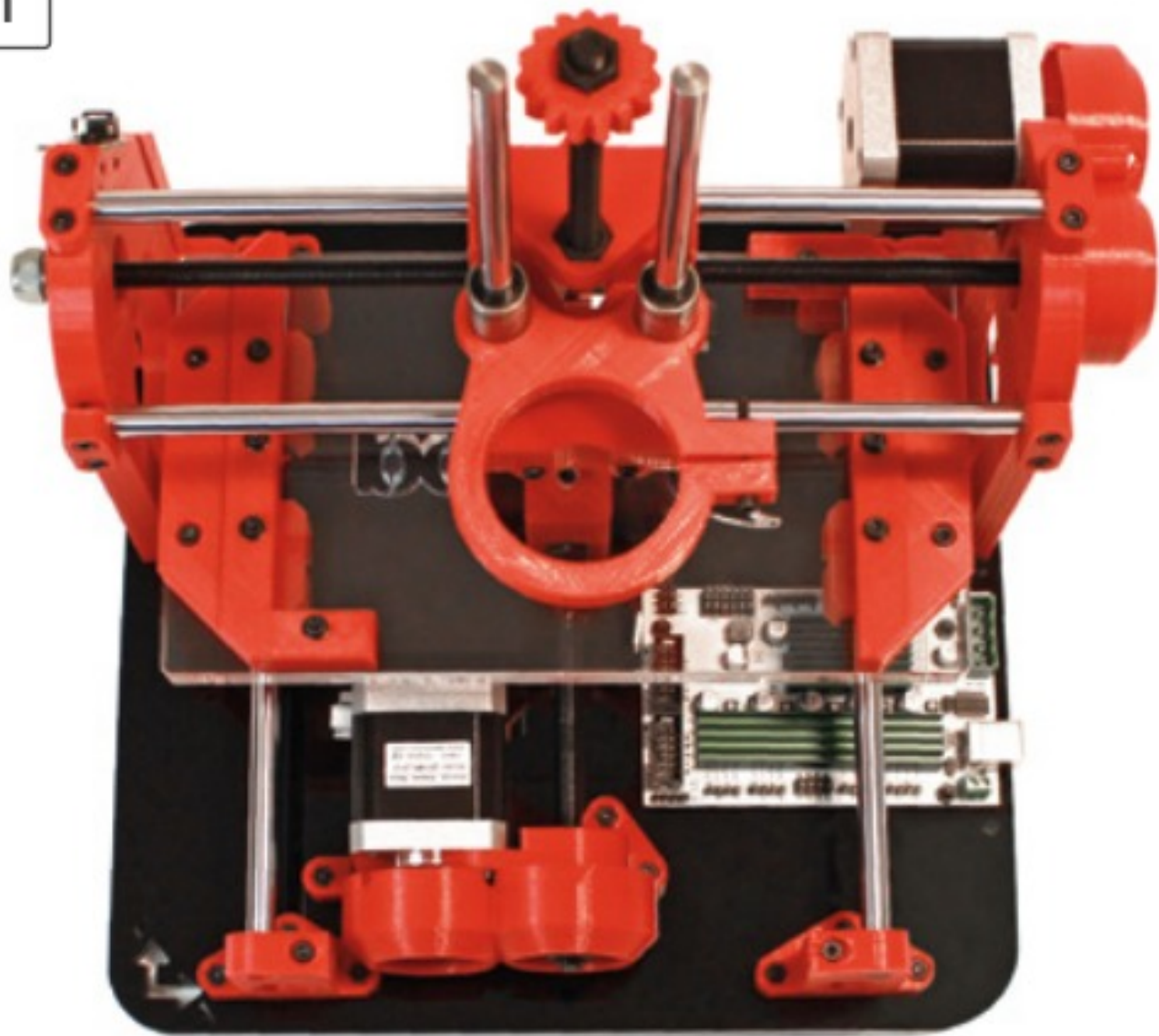

2

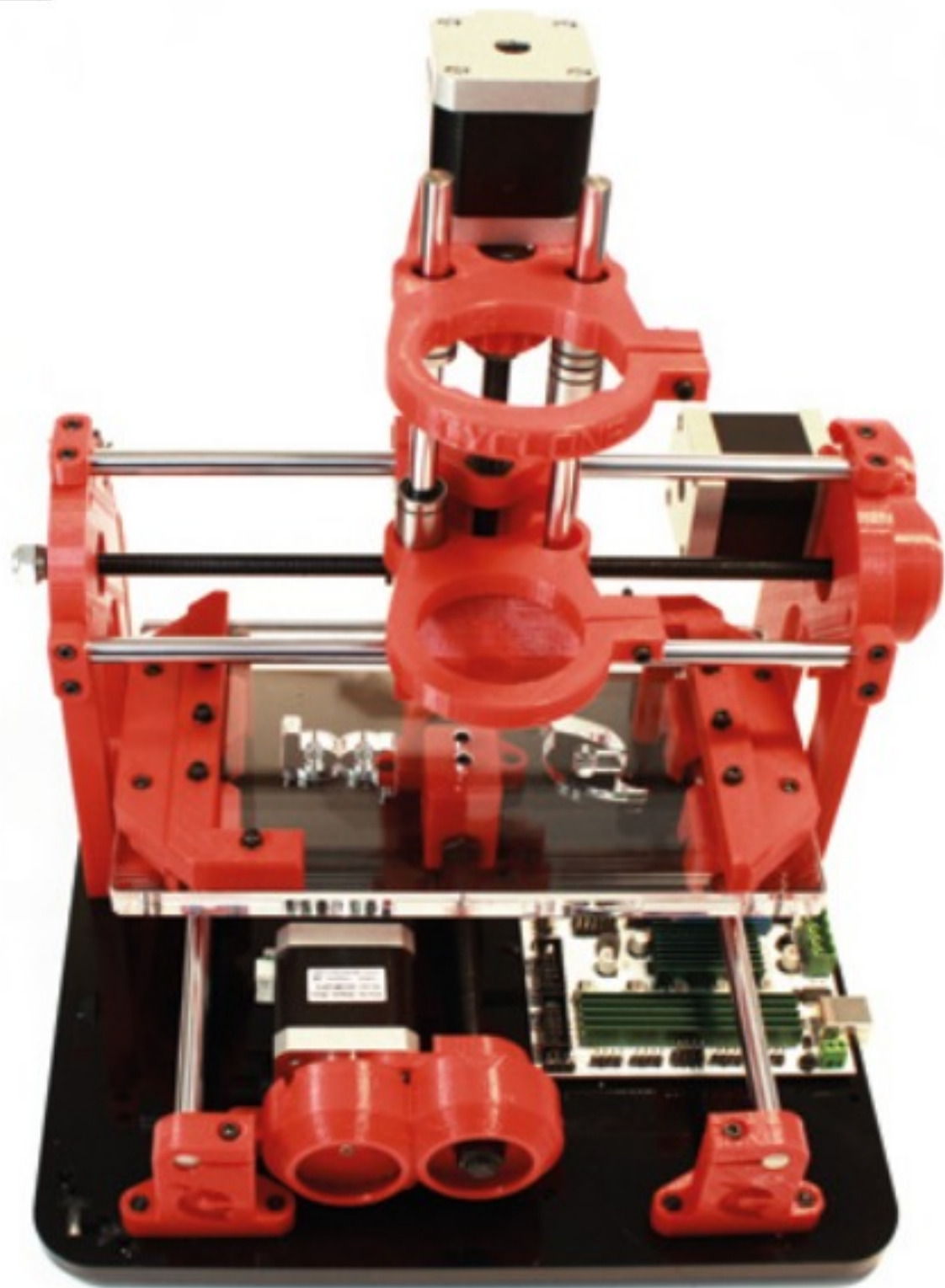

A



x1



1

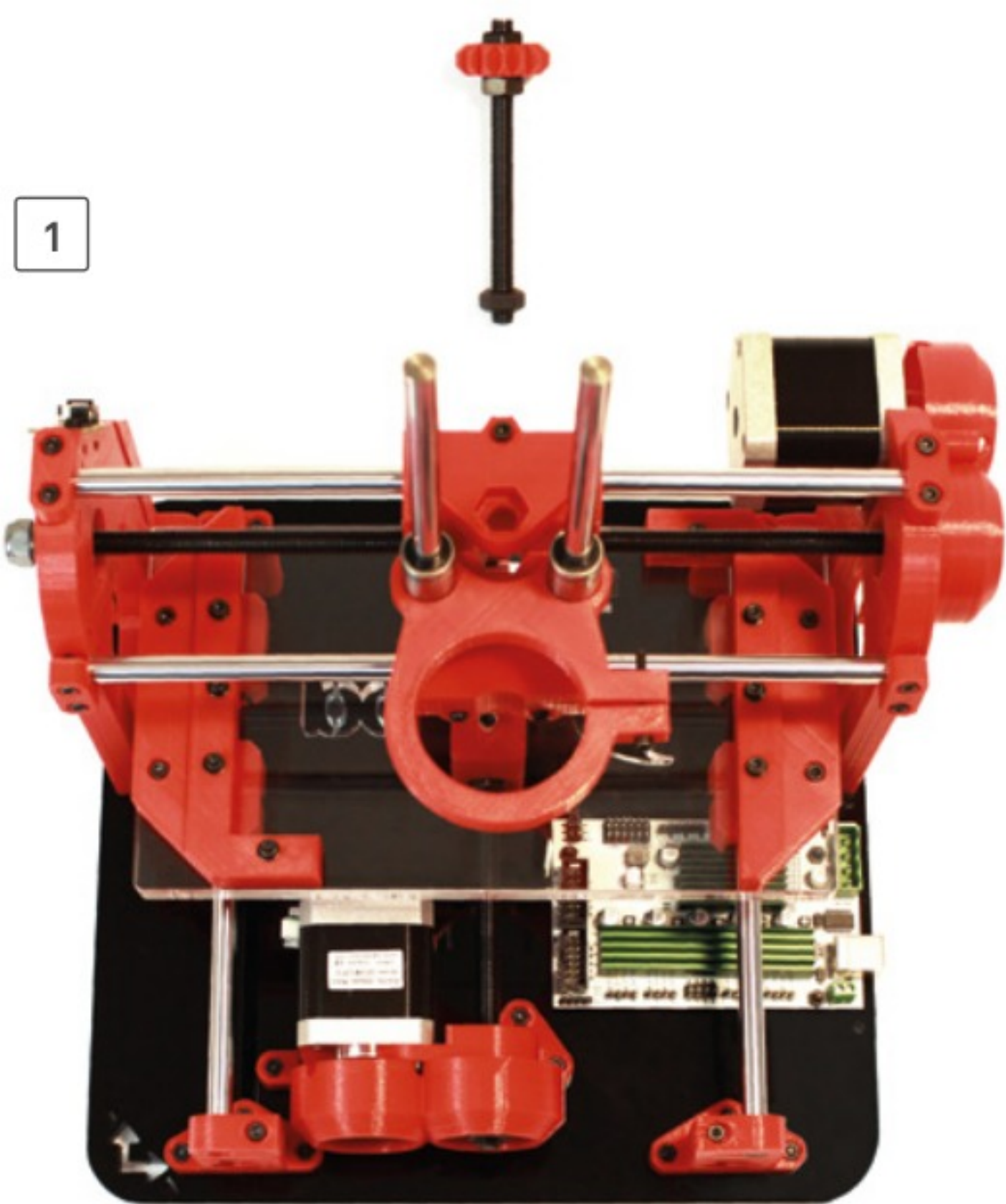

2

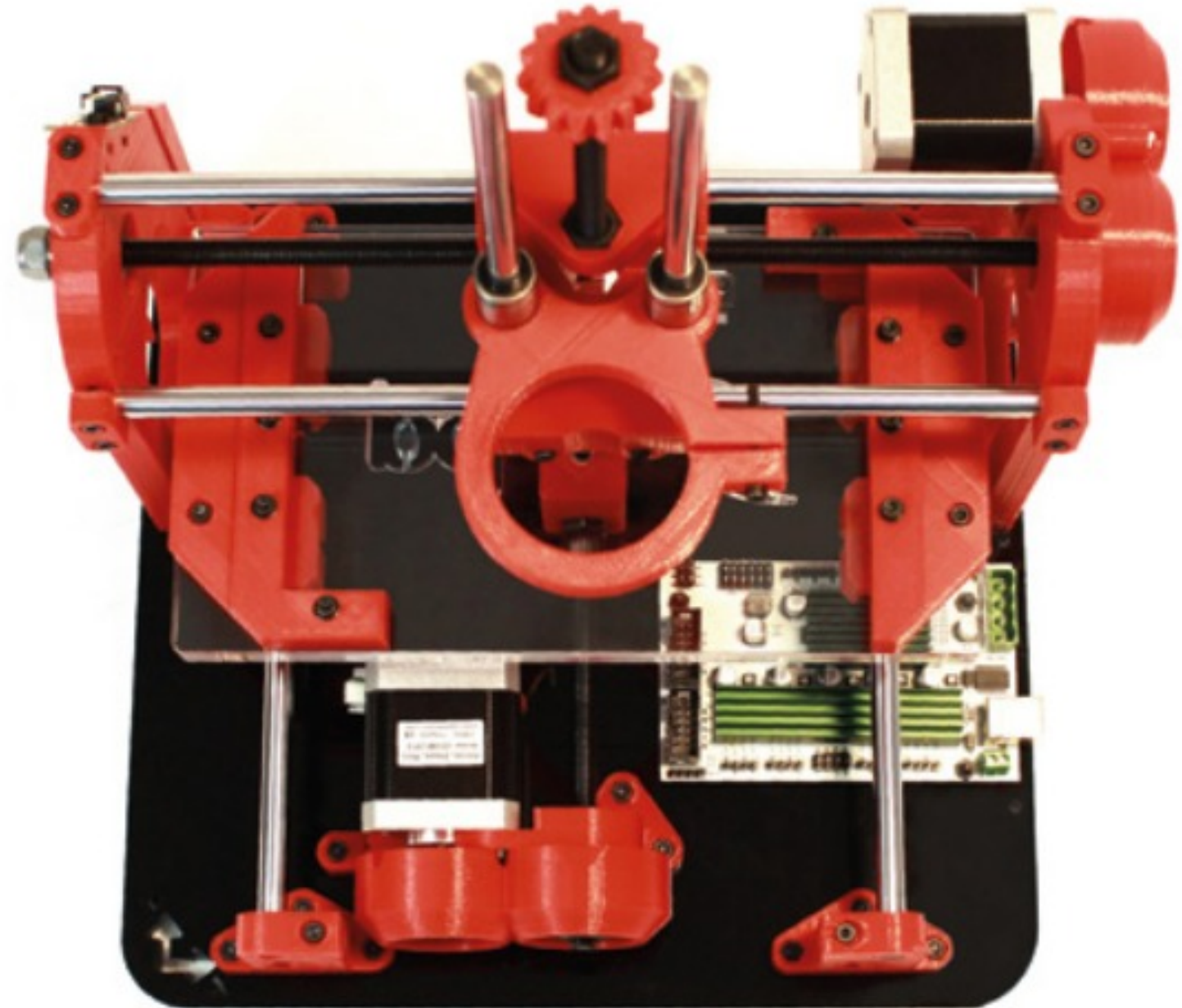

A



x1



1

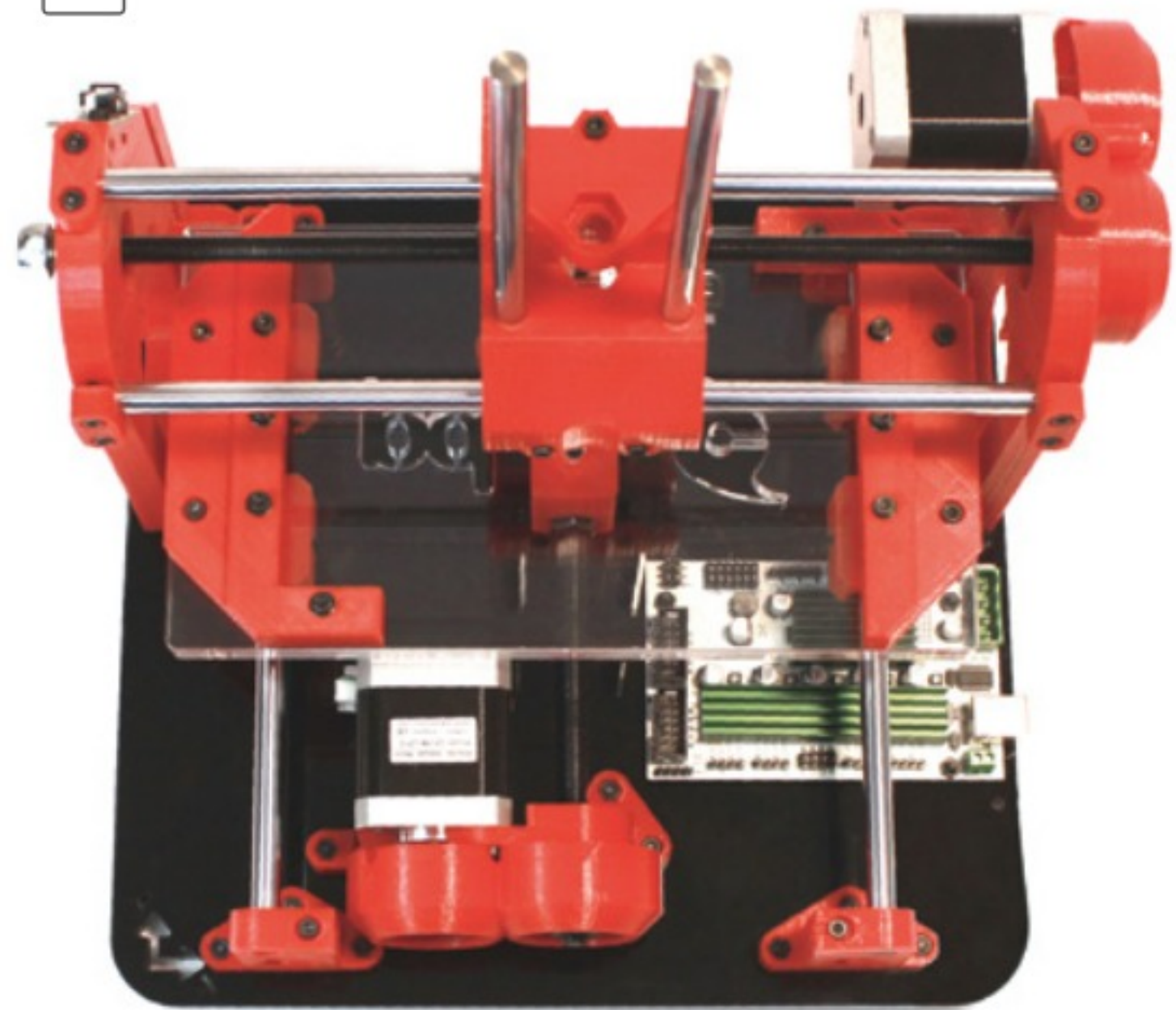

2

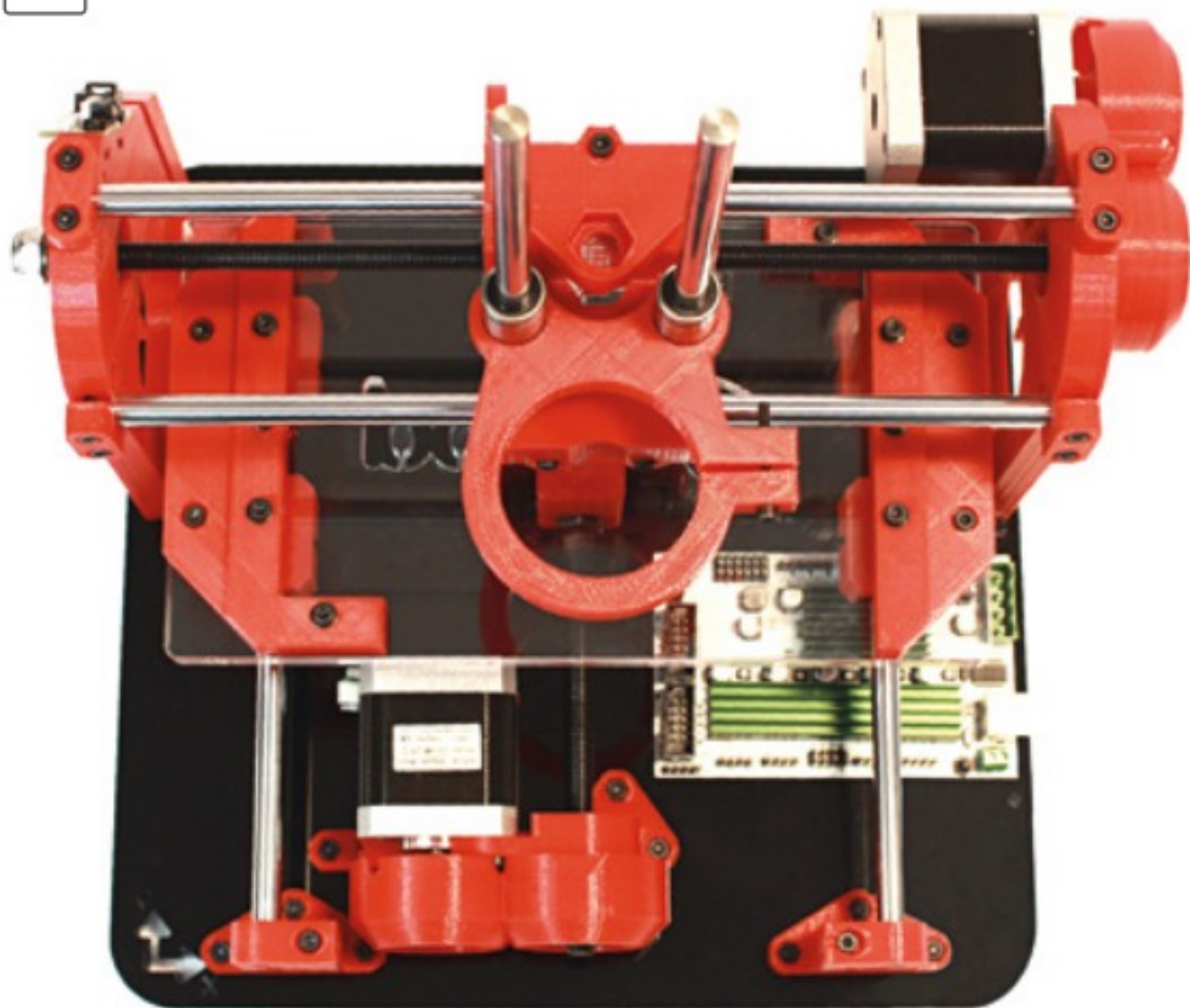

**A**



**x1**

**B**

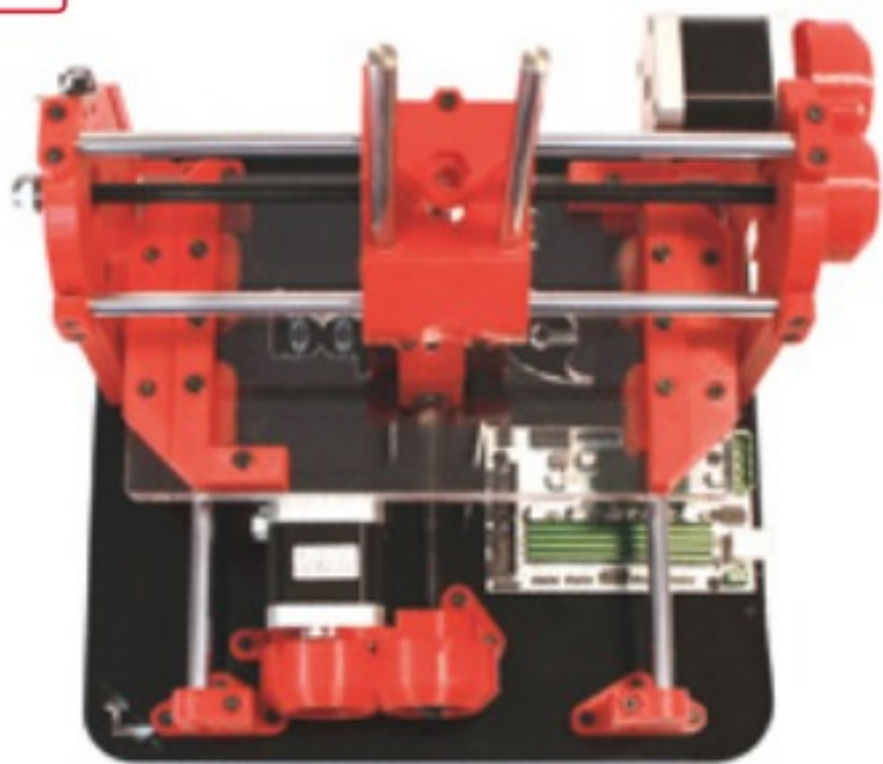

**x1**

1



2



3





A

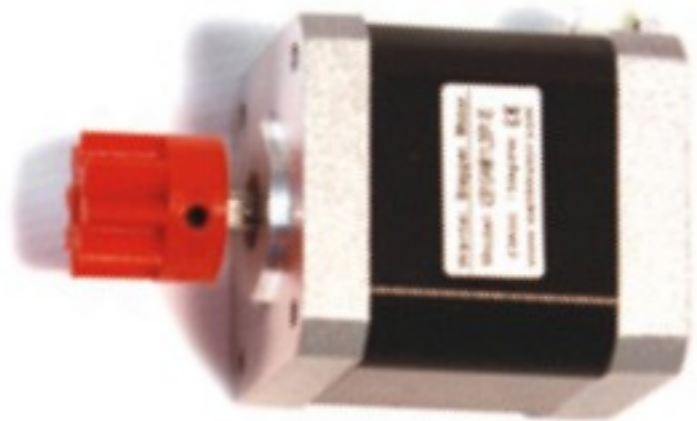

x1

B



x1

C



x4



1



2



3



4



A



x1

B



x2

C



x2

1



2



3

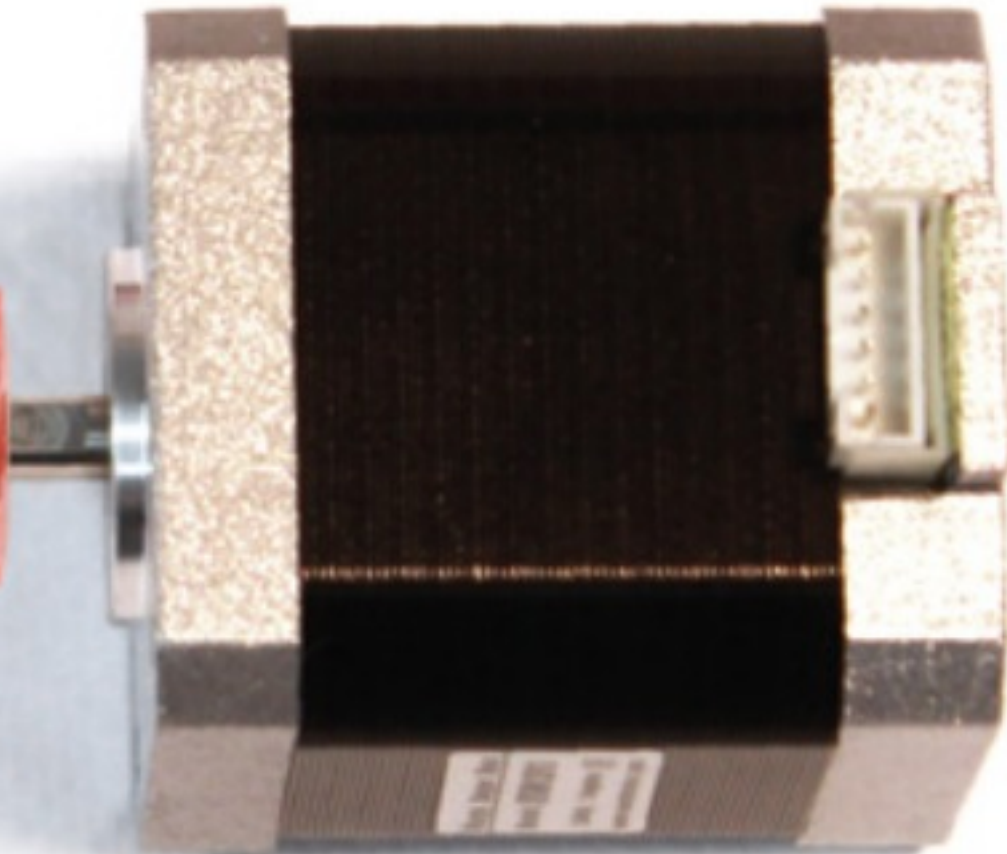

A



x1

B



x1

C



x1

D



x1



1



2



**A**



**x1**

**B**



**x1**

**C**



**x3**

1



2



3



4



**A**



**x1**

**B**



**x1**

**C**



**x1**

**D**



**x4**